



centor

E2 bifold door hardware for panels to 40kg

CONTENTS

Flexibly Manage Space	1
Centor-grade Performance	2
Effortless Operation	3
Proven durability	4
E2 Up Close	5
E2 Assurance	6
Centor Lifestyle Options	7
E2 Product Details	8
Architectural Details	9
Component Selection	12
Dropbolts	24
Door Size Calculation	28
Common Panel Layouts	29
Surelock™ Adjustment	32

THE SYSTEM THAT STARTED THE BIFOLD REVOLUTION



FLEXIBLY MANAGE SPACE

Functional and stylish, Centor Architectural's bifold door systems allow for flexibility and ease when dividing or opening space. The system that started the bifold revolution; E2 offers all the space-creating benefits of the larger E series in a refined yet economical package.

E2 is a bifold door hardware system for door panels up to a maximum of 40 kilograms. The doors are able to be opened either inward or outward, with odd or even numbers of panels in any configuration, leaving no interruptions from posts or fixed glass panels.

Available in an extensive range of finishes, including stainless steel, anodised aluminium and powdercoat, E2 is the smart choice for matching hardware to a range of residential and light commercial applications. Centor's lifestyle changing, folding systems will allow any residence or business to flexibly manage interior and exterior space with any situation that may appear.

E2 Specifications	
max opening width	16000mm
max panel weight	40kg
max panel height	3000mm
max panel width	1000mm
min panel thickness	35mm
max number of panels	16



CYCLIC TESTING TO A MINIMUM OF 50,000 CYCLES



CENTOR-GRADE PERFORMANCE

Internal environment, operational function, durability; painstaking attention to detail and an unerring commitment to quality mean 'Centor-grade' performance, whatever the category. The result is a degree of control and comfort for the end-user that matches the easy flexibility of modern design.

Rain and Wind

Centor hardware was utilised in the first tracked bifolding door system to be certified under Australian Standard AS2047, which specifies the weather performance required of external windows and sliding doors. Doors utilising the heavier E4 system have since been certified to stringent Miami-Dade County hurricane standards, the toughest testing anywhere in the world. With similar technology built into E2, impressive water performance ratings are achievable from both outward and inward opening doors. Driving rain and howling gales can be shut out completely.

Air Infiltration

The E2 system achieves its superior rain and wind resistance in part from the way it allows the folding doors to close snugly against weatherseals. In the same way, doors using E2 effectively resist air infiltration to a level up to 50 times better than a sliding door.



EFFORTLESS OPERATION

While E2's outstanding performance as part of a secure, weatherproof barrier is crucial, it's not until the doors are opened that the space-transforming benefits of the system truly come into play. For maximum enjoyment and use of the system, every effort has been made to ensure that doors glide open and slide shut with the minimum of effort – and that they continue to do so.

Quality Manufacture, Clever Design

E2 carriers, guides and pivots use stainless steel bearings custom machined to extremely fine tolerances on state-of-the-art German and Swiss machinery. Machined wheels are individually precision ground. A polypropylene floor channel lining adds to the smooth, almost silent rolling action which brings a smile to the face of the user.

Assembly and Installation

With quick-fix surface-mounted fittings assembly and installation couldn't be easier. Comprehensive instructions are included and drill jigs are available to ensure precise placement of fittings.

Adjustment

E2 is designed to operate flawlessly well into the future with built-in adjustment mechanisms making the system tolerant of an imperfect world. Surelock™, Centor's patented carrier pin locking system ensures that once heights are set they stay set. However should door panels swell or a newly built structure settle over time, the end-user can easily make vertical and lateral adjustments simply using a screwdriver.

Collaborative Design Process

E2's thoughtful design doesn't achieve the highest performance in all categories on its own. It's in its element teamed with the quality products created by Centor's many manufacturing and custom fabricating clients. The Centor technical department can assist in the design process for door sets incorporating the E2 system to ensure that the highest criteria for completed and installed doors are met even in the most unusual applications.

EXTENSIVE TESTING ENSURING YEARS OF TROUBLE-FREE USE



PROVEN DURABILITY

In addition to extensive weather testing as part of complete door systems, all individual E2 components have been extensively laboratory tested, ensuring years of trouble-free use from hardware which ages with grace.

Cyclic Testing

E2 has undergone Centor's minimum requirement of cyclic testing to a grueling 50,000 cycles without failure at maximum configuration, however many individual components are rated to over 100,000 cycles.

Corrosion Testing

Stainless steel, PVD brass, anodised aluminium and engineering-grade plastics are used throughout the E2 system with all materials carefully selected to maximise performance in any environment. Centor conducts regular corrosion testing in a salt spray chamber, fixing hardware to various substrates to ensure that E2 will perform admirably even in the most exposed applications.

Structural Testing

Structural proof load tests up to 2500 Pa (52 psf) have been achieved by maximum size doors using the E2 system. E2 hardware components have been load tested to 3KN in accordance with AS/NZS1170.0.

Finite Element Analysis

Finite Element Analysis (FEA) is a computerised simulation technique where products are exposed to virtual operating environments and accurate predictions made in terms of load and deflection. Centor undertakes FEA in the design process to ensure the best balance of performance, cost and materials in every system.



E2 UP CLOSE

Even a casual glance at the E2 system gives a strong impression of Centor's commitment to quality, but it's only upon closer inspection that the attention to detail really becomes apparent. Stacked with standard features and with an abundance of options to choose from, Centor E2 looks even better up close.

Materials and Finishes

E3 carriers, guides, pivots and hinges are available in brushed stainless steel, PVD brass finish over stainless steel, satin or gold anodised aluminium and powdercoated aluminium in black, white and custom colours. Head tracks and sills are produced in extruded aluminium with the option of satin or gold anodised or custom powdercoated finishes. The sills have an option with timber trims. Floor guide channels are produced in aluminium in various finishes with black polypropylene liner.

Panel Size and Materials

Centor's innovative hinge system enables the use of uniform width door panels regardless of the door configuration, ensuring maximum efficiency in door manufacture. Easily installed hardware can be teamed with door panels in timber, aluminium, PVC or fibreglass.

Design Features

A floating wall pivot is used to control door stile deflection and bowing on tall doors caused by wind loads or climatic conditions. Offset floor guides and floor pivots allow the guide channel to be concealed under the doors when they are closed. A straight guide option is also available. Top-rolling function means performance is never compromised by refuse in tracks.

Dropbolts

Easily installed with a dedicated router bit available from Centor, DH and DF dropbolts are available in a range of lengths and finishes to suit every E2 application. Available keyed and non-keyed, the clean-lined DH and DF dropbolts anchor doors firmly in the closed position and, together with the weather seals, eliminate rattling in strong winds.



E2 ASSURANCE

If success in modern design can be measured by the degree of comfort and ease afforded to the end-user, then Centor E2 again rates highly. E2's superior function and performance goes a long way to creating a relaxed setting, while a range of other measures allow the system to be utilised with complete confidence.

Unparalleled Security

The E2 system responds to an increasingly security conscious market place with measures designed to ensure unwanted visitors are excluded – as well as the elements.

Specifying E2

For detailed component selection, including calculating size and number of door panels, specifiers can utilise Doorcalc, Centor's free specification and ordering software. Doorcalc is available from www.centor.com.au

Architects and designers can feel comfortable simply specifying 'Centor E2' and leaving detailed component selection to the builder, joiner or fabricator.

Warranty

In line with a commitment to the highest possible quality Centor offers a 10-year warranty on E2 hardware.



WINDOW & DOOR HARDWARE CREATED FOR REAL LIFE SITUATIONS



CENTOR LIFESTYLE OPTIONS

Centor Folding

Based on the same functional geometry but with distinctive capacity and features, Centor's internal and external bifold range offers an alternative for every application. From the smallest folding window to four metre high walls of glass which fold away in seconds, Centor bifold systems create a formidable barrier against the elements, yet glide open with finger-tip ease.

EW and E2 are the mainstays of this flexible product range. Developed first and constantly upgraded since their inception they remain the perfect choice for the private residence or lighter commercial application. E2i is Centor's internal bifold system which has no sill or guide channel, allowing for seamless transitions between indoor spaces.

E3 and E4 are Centor's responses to the demands of architects and consumers wishing to expand the potential of bifold innovation into heavier-duty residential and commercial applications. E3 doubles the panel weight capacity of the E2 system, making even

sturdier panel materials and double glazing possible. The E4 system takes it even further with a massive 120kg panel weight capacity and substantially increased height, width and overall measurement specifications, ensuring that Centor bifold systems remain the perfect choice for every project.

Centor Screening

E2 is fully compatible with the ES2 Insect Door Screen, Centor's superbly effective, world-first integrated screening solution for bifold scale openings.

E2 PRODUCT DETAILS

Downloadable DXF or DWG files ready for use in your own documentation are a convenient resource for architects and specifiers wishing to use Centor systems.

E2 DXF or DWG files can be downloaded from www.centor.com.au

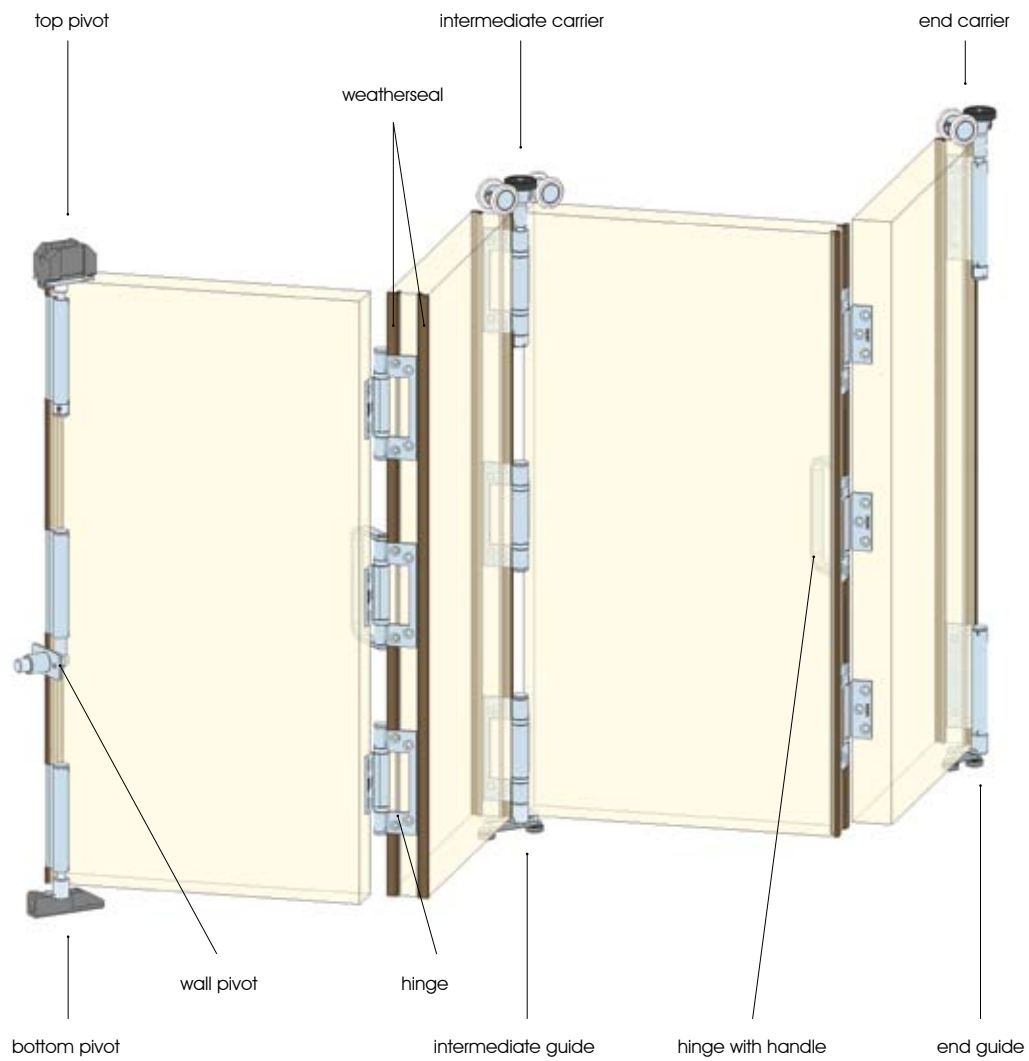

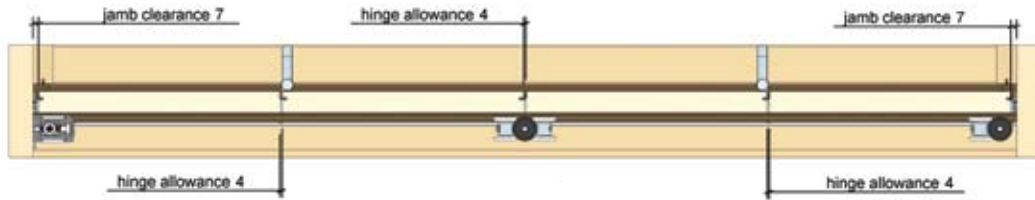

E2-001.DXF

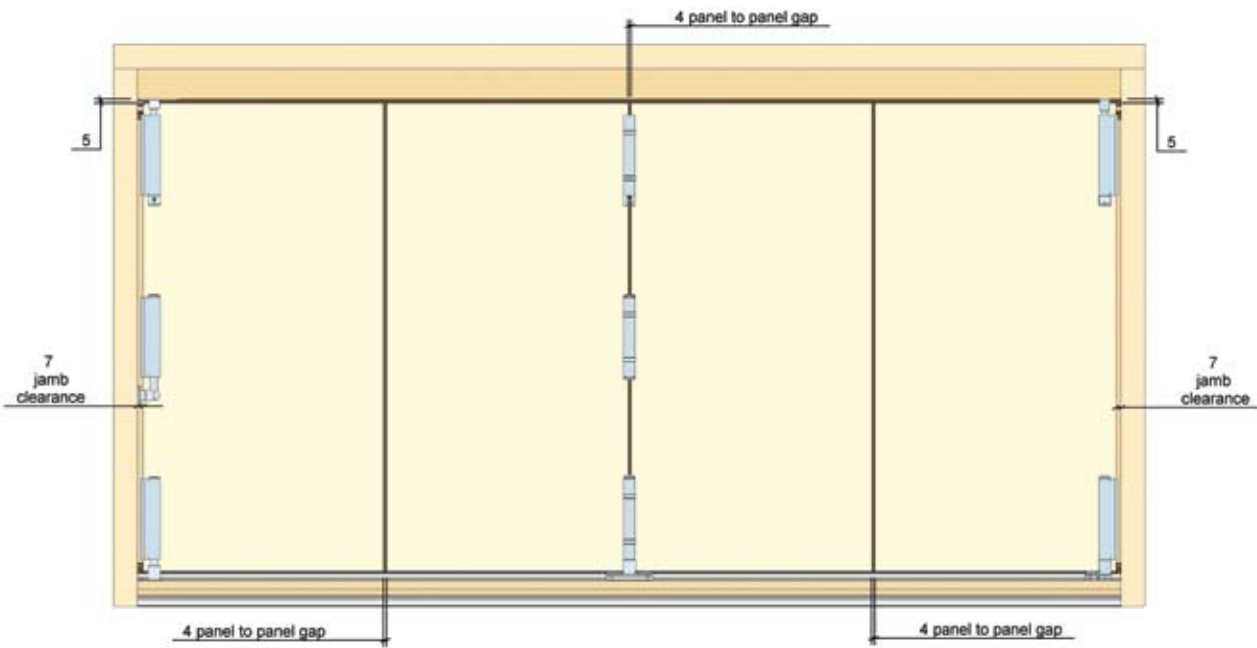

E2-002.DXF

ARCHITECTURAL DETAIL

Straight Guide

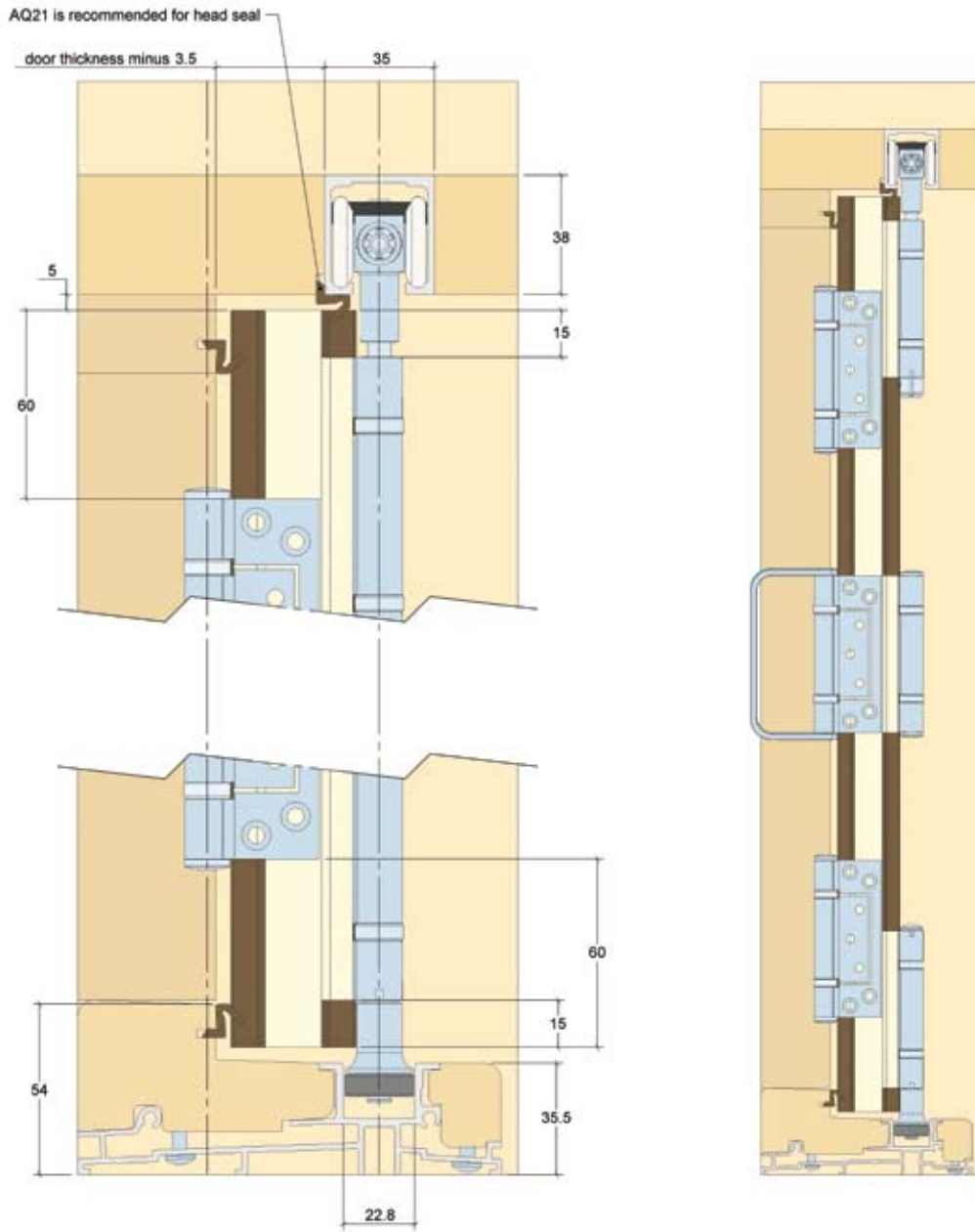

E2-004.DXF

ARCHITECTURAL DETAIL

Concealed Guide

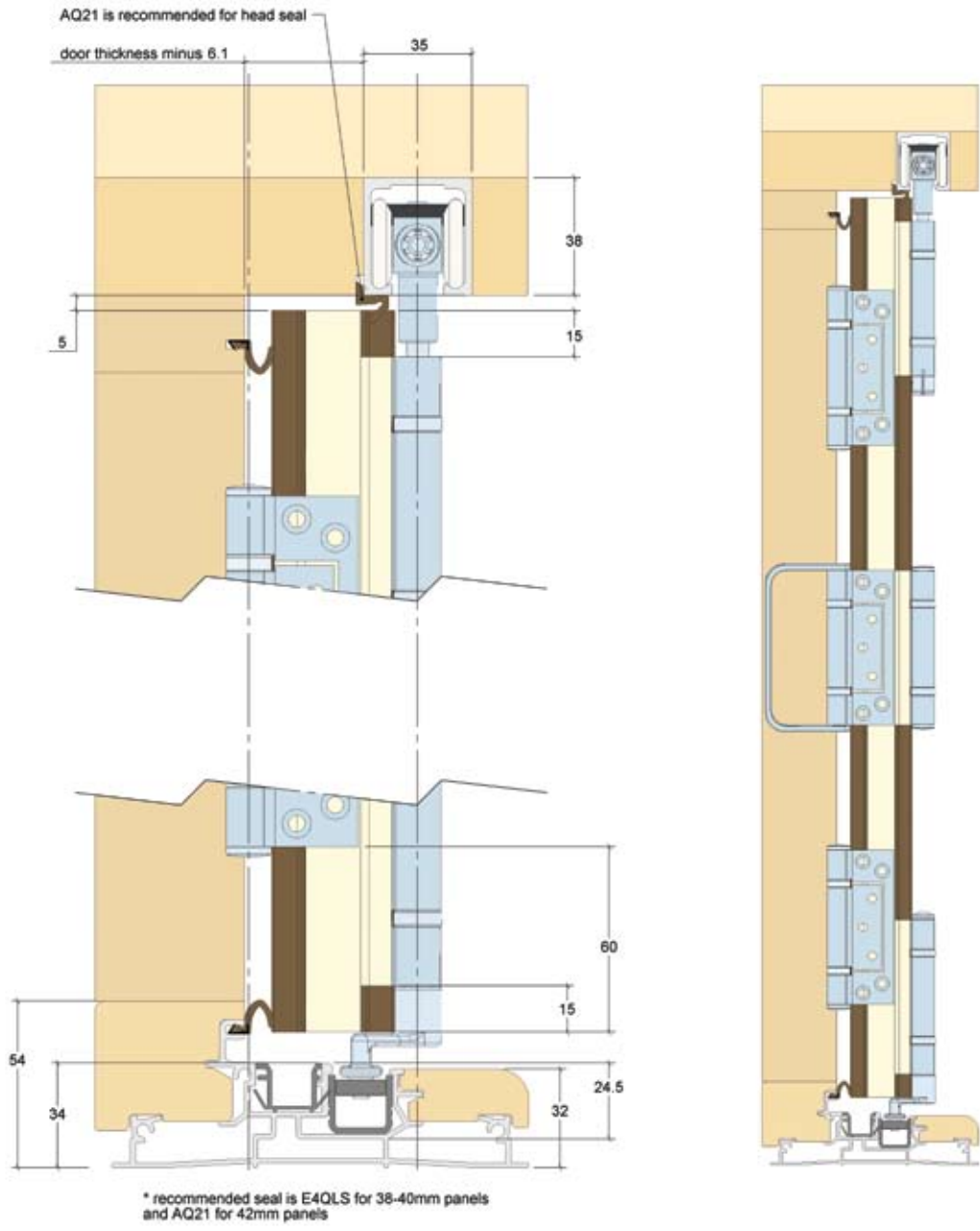



COMPONENT SELECTION

E2 is specified with 5 separate component groups. Components are required from each group to build an E2 folding door system.

- 1 **Track** – choose surface finish and size required to suit opening
- 2 **Sill Assembly** – choose a pre-assembled Centor sill with surface finish, floor guide type and size to suit opening
or **Channel** – choose material, surface finish, floor guide type and size of floor channel to suit opening
- 3 **Door Hardware Sets** – choose surface finish, floor guide type and sets required to suit panel layout
- 4 **Dropbolts** – choose surface finish, type, size & number required to suit panel layout
- 5 **Weather Seals** – choose colour, type and amount of each seal required to suit opening size and panel layout

TRACK



PART	TRACK	PRODUCT CODE	DESCRIPTION
	aluminium track	14TA2N	2000mm aluminium track, natural anodised
		14TA2G	2000mm aluminium track, gold anodised
		14TA2PC	2000mm aluminium track, custom powdercoat
		14TA3N	3000mm aluminium track, natural anodised
		14TA3G	3000mm aluminium track, gold anodised
		14TA3PC	3000mm aluminium track, custom powdercoat
		14TA4N	4000mm aluminium track, natural anodised
		14TA4G	4000mm aluminium track, gold anodised
		14TA4PC	4000mm aluminium track, custom powdercoat
		14TA6N	5700mm aluminium track, natural anodised
		14TA6G	5700mm aluminium track, gold anodised
		14TA6PC	5700mm aluminium track, custom powdercoat
	aluminium track, machined	14TAM2N	2000mm machined track, natural anodised
		14TAM3N	3000mm machined track, natural anodised
		14TAM4N	4000mm machined track, natural anodised
		14TAM6N	5700mm machined track, natural anodised

COMPONENT SELECTION

CHANNEL

PART	CHANNEL	PRODUCT CODE	DESCRIPTION
	straight channel 26mm	E2FCA2N	2000mm 19 x 26mm aluminium channel, natural anodised
		E2FCA2G	2000mm 19 x 26mm aluminium channel, gold anodised
		E2FCB2	2000mm 19 x 26mm brass channel
		E2FCA3N	3000mm 19 x 26mm aluminium channel, natural anodised
		E2FCA3G	3000mm 19 x 26mm aluminium channel, gold anodised
		E2FCB3	3000mm 19 x 26mm brass channel
		E2FCA4N	4000mm 19 x 26mm aluminium channel, natural anodised
		E2FCA4G	4000mm 19 x 26mm aluminium channel gold anodised
		E2FCB4	4000mm 19 x 26mm brass channel
		E2FCA6N	5700mm 19 x 26mm aluminium channel, natural anodised
		E2FCA6G	5700mm 19 x 26mm aluminium channel, gold anodised
E2FCB6	5700mm 19 x 26mm brass channel		

UNDERDOOR GUIDE CHANNELS

PART	CHANNEL	PRODUCT CODE	DESCRIPTION
	concealed channel 24mm, retainer and poly channel	E22FCR4GP	4000mm floor channel retainer, gold anodised with poly channel
		E22FCR4NP	4000mm floor channel retainer, natural anodised with poly channel
		E22FCR6GP	5700mm floor channel retainer, gold anodised with poly channel
		E22FCR6NP	5700mm floor channel retainer, natural anodised with poly channel
	concealed channel 24mm, retainer	E22FCR4G	4000mm floor channel retainer, gold anodised
		E22FCR4N	4000mm floor channel retainer, natural anodised
		E22FCR6G	5700mm floor channel retainer, gold anodised
		E22FCR6N	5700mm floor channel retainer, natural anodised
	concealed channel 21mm, poly channel	E22FCP4	4000mm floor channel, polypropylene
		E22FCP6	5700mm floor channel, polypropylene
	concealed channel 21mm, brass	E22FCB4	4000mm 20.5 x 18.6mm floor channel, brass
		E22FCB6	5700mm 20.5 x 18.6mm floor channel, brass

COMPONENT SELECTION

LEFT CARRIER SET – STRAIGHT GUIDE*

PART	PRODUCT CODE	DESCRIPTION
	E22LCSS	left hand carrier set, stainless steel
	E22LCSN	left hand carrier set, natural anodised
	E22LCSG	left hand carrier set, gold anodised
	E22LCSL	left hand carrier set, black powdercoat
	E22LCSW	left hand carrier set, white powdercoat
	E22LCSPC	left hand carrier set, custom powdercoat
	E22LCSTG	left hand carrier set, PVD brass

*For use on doorsets with fast-fix hinges

LEFT CARRIER SET – CONCEALED GUIDE*

PART	PRODUCT CODE	DESCRIPTION
	E2CLCSS	concealed left hand carrier set, stainless steel
	E2CLCSN	concealed left hand carrier set, natural anodised
	E2CLCSG	concealed left hand carrier set, gold anodised
	E2CLCSL	concealed left hand carrier set, black powdercoat
	E2CLCSW	concealed left hand carrier set, white powdercoat
	E2CLCSTG	concealed left hand carrier set, PVD brass

*For use on doorsets with fast-fix hinges

COMPONENT SELECTION

REBATED LEFT CARRIER SETS – STRAIGHT GUIDE*

PART	PRODUCT CODE	DESCRIPTION
	E22RLCSS	rebated left hand carrier set, stainless steel
	E22RLCSTG	rebated left hand carrier set, PVD brass

*For use on rebated doorsets with fast-fix hinges

REBATED LEFT CARRIER SETS – CONCEALED GUIDE*

PART	PRODUCT CODE	DESCRIPTION
	E2CRLCSS	concealed rebated left hand carrier set, stainless steel
	E2CRLCSTG	concealed rebated left hand carrier set, PVD brass

*For use on rebated doorsets with fast-fix hinges

COMPONENT SELECTION

RIGHT CARRIER SET – STRAIGHT GUIDE*

PART	PRODUCT CODE	DESCRIPTION
	E22RCSS	right hand carrier set, stainless steel
	E22RCSN	right hand carrier set, natural anodised
	E22RCSG	right hand carrier set, gold anodised
	E22RCSL	right hand carrier set, black powdercoat
	E22RCSW	right hand carrier set, white powdercoat
	E22RCSPC	right hand carrier set, custom powdercoat
	E22RCSTG	right hand carrier set, PVD brass

*For use on doorsets with fast-fix hinges

RIGHT CARRIER SET – CONCEALED GUIDE*

PART	PRODUCT CODE	DESCRIPTION
	E2CRCSS	concealed right hand carrier set, stainless steel
	E2CRCSN	concealed right hand carrier set, natural anodised
	E2CRCSG	concealed right hand carrier set, gold anodised
	E2CRCSL	concealed right hand carrier set, black powdercoat
	E2CRCSW	concealed right hand carrier set, white powdercoat
	E2CRCSTG	concealed right hand carrier set, PVD brass

*For use on doorsets with fast-fix hinges

COMPONENT SELECTION

REBATED RIGHT CARRIER SETS – STRAIGHT GUIDE*

PART	PRODUCT CODE	DESCRIPTION
	E22RRCSS	rebated right hand carrier set, stainless steel
	E22RRCSTG	rebated right hand carrier set, PVD brass

*For use on rebated doorsets with fast-fix hinges

REBATED RIGHT CARRIER SETS – CONCEALED GUIDE*

PART	PRODUCT CODE	DESCRIPTION
	E2CRRCSS	concealed rebated right hand carrier set, stainless steel
	E2CRRCSTG	concealed rebated right hand carrier set, PVD brass

*For use on rebated doorsets with fast-fix hinges

COMPONENT SELECTION

INTERMEDIATE CARRIER SETS – STRAIGHT GUIDE

PART	PRODUCT CODE	DESCRIPTION
Fast-fix 	E22ICSS	intermediate carrier set, stainless steel
	E22ICSN	intermediate carrier set, natural anodised
	E22ICSG	intermediate carrier set, gold anodised
	E22ICSL	intermediate carrier set, black powdercoat
	E22ICSW	intermediate carrier set, white powdercoat
	E22ICSPC	intermediate carrier set, custom powdercoat
	E22ICSTG	intermediate carrier set, PVD brass

INTERMEDIATE CARRIER SETS – CONCEALED GUIDE

PART	PRODUCT CODE	DESCRIPTION
Fast-fix 	E2CICSS	concealed intermediate carrier set, stainless steel
	E2CICSN	concealed intermediate carrier set, natural anodised
	E2CICSG	concealed intermediate carrier set, gold anodised
	E2CICSL	concealed intermediate carrier set, black powdercoat
	E2CICSW	concealed intermediate carrier set, white powdercoat
	E2CICSTG	concealed intermediate carrier set, PVD brass

MEETING CARRIER SET – STRAIGHT GUIDE*

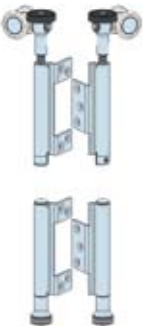
PART	PRODUCT CODE	DESCRIPTION
	E22MCSS	meeting carrier set, stainless steel
	E22MCSN	meeting carrier set, natural anodised
	E22MCSG	meeting carrier set, gold anodised
	E22MCSL	meeting carrier set, black powdercoat
	E22MCSSW	meeting carrier set, white powdercoat
	E22MCSPC	meeting carrier set, custom powdercoat
	E22MCSTG	meeting carrier set, PVD brass

*Use with doorsets with fast-fix hinges

COMPONENT SELECTION

MEETING CARRIER SET – CONCEALED GUIDE*

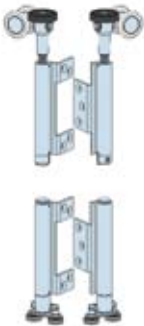
PART	PRODUCT CODE	DESCRIPTION
	E2CMCSS	concealed meeting carrier set, stainless steel
	E2CMCSN	concealed meeting carrier set, natural anodised
	E2CMCSG	concealed meeting carrier set, gold anodised
	E2CMCSL	concealed meeting carrier set, black powdercoat
	E2CMCSW	concealed meeting carrier set, white powdercoat
	E2CMCSTG	concealed meeting carrier set, PVD brass

*Use with doorsets with fast-fix hinges

PIVOT SET – STRAIGHT GUIDE*

PART	PRODUCT CODE	DESCRIPTION
	E22PSS	pivot set, stainless steel
	E22PSN	pivot set, natural anodised
	E22PSG	pivot set, gold anodised
	E22PSL	pivot set, black powdercoat
	E22PSW	pivot set, white powdercoat
	E22PSPC	pivot set, custom powdercoat
	E22PSTG	pivot set, PVD brass

*For use on doorsets with fast-fix hinges



PIVOT SET – CONCEALED GUIDE*

PART	PRODUCT CODE	DESCRIPTION
	E2CPSS	concealed pivot set, stainless steel
	E2CPSN	concealed pivot set, natural anodised
	E2CPSG	concealed pivot set, gold anodised
	E2CPSL	concealed pivot set, black powdercoat
	E2CPSW	concealed pivot set, white powdercoat
	E2CPSTG	concealed pivot set, PVD brass

*For use on doorsets with fast-fix hinges

COMPONENT SELECTION

HINGE SETS – FAST-FIX



PART	PRODUCT CODE	DESCRIPTION
<p>with handle</p> 	E22HSS	hinge set, stainless steel
	E22HSNN	hinge set, natural anodised, natural anodised handle
	E22HSNL	hinge set, natural anodised, black powdercoat handle
	E22HSGG	hinge set, gold anodised, gold anodised handle
	E22HSGL	hinge set, gold anodised, black powdercoat handle
	E22HSLL	hinge set, black powdercoat, black powdercoat handle
	E22HSWW	hinge set, white powdercoat, white powdercoat handle
	E22HSWL	hinge set, white powdercoat, black powdercoat handle
E22HSTG	hinge set, PVD brass	
<p>with no handle</p> 	E22HNHSS	no handle hinge set, stainless steel
	E22HNHNS	no handle hinge set, natural anodised
	E22HNHSG	no handle hinge set, gold anodised
	E22HNHSL	no handle hinge set, black powdercoat
	E22HNHSW	no handle hinge set, white powdercoat
	E22HNHSPC	no handle hinge set, custom powdercoat
	E22HNHSTG	no handle hinge set, PVD brass

COMPONENT SELECTION

HALF OFFSET HINGE SETS – FAST-FIX

PART	PRODUCT CODE	DESCRIPTION
	E22HHSS	half offset hinge set, stainless steel
	E22HHSN	half offset hinge set, natural anodised
	E22HHSG	half offset hinge set, gold anodised
	E22HHSL	half offset hinge set, black powdercoat
	E22HHSW	half offset hinge set, white powdercoat
	E22HHSPC	half offset hinge set, custom powdercoat
	E22HHSTG	half offset hinge set, PVD brass
	E22HHNHSS	no handle half offset hinge set, stainless steel
	E22HHNHSN	no handle half offset hinge set, natural anodised
	E22HHNHSG	no handle half offset hinge set, gold anodised
	E22HHNHSL	no handle half offset hinge set, black powdercoat
	E22HHNHSW	no handle half offset hinge set, white powdercoat
	E22HHNHSPC	no handle half offset hinge set, custom powdercoat
	E22HHNHSTG	no handle half offset hinge set, PVD brass

ECLIPSE SILL

PART	PRODUCT CODE	DESCRIPTION
	E2IS4N	4000mm inward sill, natural anodised
	E2IS4G	4000mm inward sill, gold anodised
	E2IS4R	4000mm inward sill, bronze anodised
	E2IS6N	5700mm inward sill, natural anodised
	E2IS6G	5700mm inward sill, gold anodised
	E2IS6R	5700mm inward sill, bronze anodised
	E2IS4NT	4000mm inward sill, natural anodised and timber
	E2IS4RT	4000mm inward sill, bronze anodised and timber
	E2IS6NT	5700mm inward sill, natural anodised and timber
	E2IS6RT	5700mm inward sill, bronze anodised and timber

COMPONENT SELECTION

SILL – OUTWARD E2/E3 SILL WITH TIMBER

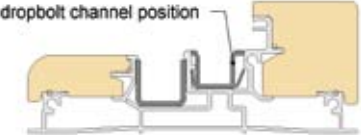
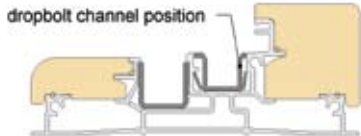
PART	PRODUCT CODE	DESCRIPTION
a) 	E2CS30NKWL	3000mm concealed sill with timber, natural anodised with kwila
	E2CS30RKWL	3000mm concealed sill with timber, bronze anodised with kwila
	E2CS42NKWL	4200mm concealed sill with timber, natural anodised with kwila
	E2CS42RKWL	4200mm concealed sill with timber, bronze anodised with kwila
b) 	E2CS48NKWL	4800mm concealed sill with timber, natural anodised with kwila
	E2CS48RKWL	4800mm concealed sill with timber, bronze anodised with kwila
	E2CS57NKWL	5700mm concealed sill with timber, natural anodised with kwila
	E2CS57RKWL	5700mm concealed sill with timber, bronze anodised with kwila

a) assembly for 38mm doors

b) assembly for 40mm doors (dropbolt channel reversed)

SILL – INWARD E2/E3 SILL WITH TIMBER

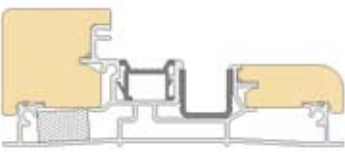
PART	PRODUCT CODE	DESCRIPTION
	E2CIS57NKWL	E2/E3 5700mm concealed external inward sill, natural anodised with kwila

SILL – E2/E3 CONCEALED NARROW SILL

PART	PRODUCT CODE	DESCRIPTION
	E2CNS4N	E2/E3 4000mm concealed narrow sill, natural anodised
	E2CNS6N	E2/E3 5700mm concealed narrow sill, natural anodised

COMPONENT SELECTION



WALL PIVOT SETS

PART	PRODUCT CODE	DESCRIPTION
	E22WPSS	wall pivot set, stainless steel
	E22WPSW	wall pivot set, white powdercoat
	E22WPSTG	wall pivot set, PVD brass

EXTERNAL HANDLES

PART	PRODUCT CODE	DESCRIPTION
	E22EHS	external handle, stainless
	E22EHN	external handle, natural anodised
	E22EHG	external handle, gold anodised
	E22EHL	external handle, black powdercoat
	E22EHW	external handle, white powdercoat
	E22EHPC	external handle, custom powdercoat

INTERNAL HANDLE

PART	PARTS ON PANELS	PRODUCT CODE	DESCRIPTION
		DF1IPH	internal pull handle, stainless steel

AVAILABLE IN A
RANGE OF LENGTHS
AND FINISHES



DROPBOLTS

Centor's stylish, flush-mounting dropbolts are the ideal solution for fastening or securing bifold doors based on the E3 system. Easily installed with a dedicated router bit available from Centor, DH and DF dropbolts are available in a range of lengths and finishes to suit many applications. The bolts are available keyed alike and may be re-keyed by a professional locksmith.

Centor DH

Suited to outward opening bifold doors, french doors and sliding doors, Centor DH features an extended 40mm throw. Rated to resist the most extreme wind conditions (up to 450kg force in certain timbers) DH can be specified in applications where its distinctive square-edged styling is preferred. Available in 200mm and 400mm lengths, they come in natural and gold anodised, chrome, brushed metallic and custom powdercoated finishes. Keyed DH dropbolts feature a unique bifold damage-proofing mechanism which prevents the bolt being operated while the key remains in the lock.

Centor DF

Rated to resist the most extreme wind conditions (up to 450kg force in certain timbers) DF dropbolts feature rounded styling and are suited to use with outward opening bifold doors, french doors and sliding doors. Available in 200mm, 400mm, 600mm and 1000mm lengths with a 20mm throw they come in natural and gold anodised, chrome, brushed metallic and custom powdercoated finishes. Keyed DF dropbolts feature a unique bifold damage-proofing mechanism which prevents the bolt being operated while the key remains in the lock.



Centor DH dropbolt



Centor DF dropbolt

DROPBOLTS / OUTWARD OPENING

DH – KEYED

PARTS	PRODUCT CODE	DESCRIPTION
	DBHA200KSG	200mm dropbolt, keyed, gold anodised
	DBHA200KSL	200mm dropbolt, keyed, black powdercoat
	DBHA200KSW	200mm dropbolt, keyed, white powdercoat
	DBHA200KSPC	200mm dropbolt, keyed, custom powdercoat
	DBHA200KSX	200mm dropbolt, keyed, brushed metallic
	DBHA400KSG	400mm dropbolt, keyed, gold anodised
	DBHA400KSL	400mm dropbolt, keyed, black powdercoat
	DBHA400KSW	400mm dropbolt, keyed, white powdercoat
	DBHA400KSPC	400mm dropbolt, keyed, custom powdercoat
	DBHA400KSX	400mm dropbolt, keyed, brushed metallic

Custom powdercoat available by special order.

DH – NON-KEYED

PARTS	PRODUCT CODE	DESCRIPTION
	DBHA200NSG	200mm dropbolt, non-keyed, gold anodised
	DBHA200NSL	200mm dropbolt, non-keyed, black powdercoat
	DBHA200NSW	200mm dropbolt, non-keyed, white powdercoat
	DBHA200NSPC	200mm dropbolt, non-keyed, custom powdercoat
	DBHA200NSX	200mm dropbolt, non-keyed, brushed metallic
	DBHA400NSG	400mm dropbolt, non-keyed, gold anodised
	DBHA400NSL	400mm dropbolt, non-keyed, black powdercoat
	DBHA400NSW	400mm dropbolt, non-keyed, white powdercoat
	DBHA400NSPC	400mm dropbolt, non-keyed, custom powdercoat
	DBHA400NSX	400mm dropbolt, non-keyed, brushed metallic

Custom powdercoat available by special order.

ROUTER BIT

PART	PRODUCT CODE	DESCRIPTION
	DBFORB	dedicated router bit for professional installation of Centor Architectural DH, DF, DL and DO dropbolts

CUPS

PART	PRODUCT CODE	DESCRIPTION
	DBCS	dropbolt cup, stainless steel
	DBC B	dropbolt cup, brass

DROPBOLTS / OUTWARD OPENING

DF – KEYED

PART	PRODUCT CODE	DESCRIPTION
	DBFO200KRN	200mm dropbolt, keyed, natural anodised
	DBFO200KRG	200mm dropbolt, keyed, gold anodised
	DBFO200KRL	200mm dropbolt, keyed, black powdercoat
	DBFO200KRW	200mm dropbolt, keyed, white powdercoat
	DBFO200KRPC	200mm dropbolt, keyed, custom powdercoat
	DBFO200KRX	200mm dropbolt, keyed, brushed metallic
	DBFO200KRC	200mm dropbolt, keyed, chrome
	DBFO400KRN	400mm dropbolt, keyed, natural anodised
	DBFO400KRG	400mm dropbolt, keyed, gold anodised
	DBFO400KRX	400mm dropbolt, keyed, brushed metallic
	DBFO600KRN	600mm dropbolt, keyed, natural anodised
	DBFO600KRG	600mm dropbolt, keyed, gold anodised
	DBFO600KRX	600mm dropbolt, keyed, brushed metallic
	DBFO1000KRN	1000mm dropbolt, keyed, natural anodised
	DBFO1000KRX	1000mm dropbolt, keyed, brushed metallic

Custom powdercoat available by special order.

DF – NON-KEYED

PART	PRODUCT CODE	DESCRIPTION
	DBFO200NRG	200mm dropbolt, non-keyed, gold anodised
	DBFO200NRN	200mm dropbolt, non-keyed, natural anodised
	DBFO200NRL	200mm dropbolt, non-keyed, black powdercoat
	DBFO200NRW	200mm dropbolt, non-keyed, white powdercoat
	DBFO200NRPC	200mm dropbolt, non-keyed, custom powdercoat
	DBFO200NRX	200mm dropbolt, non-keyed, brushed metallic
	DBFO200NRC	200mm dropbolt, non-keyed, chrome
	DBFO400NRN	400mm dropbolt, non-keyed, natural anodised
	DBFO400NRG	400mm dropbolt, non-keyed, gold anodised
	DBFO400NRX	400mm dropbolt, non-keyed, brushed metallic
	DBFO600NRN	600mm dropbolt, non-keyed, natural anodised
	DBFO600NRG	600mm dropbolt, non-keyed, gold anodised
	DBFO600NRX	600mm dropbolt, non-keyed, brushed metallic
	DBFO1000NRN	1000mm dropbolt, non-keyed, natural anodised
	DBFO1000NRX	1000mm dropbolt, non-keyed, brushed metallic

Custom powdercoat available by special order.

DROPBOLTS / OUTWARD OPENING

ROUTER BIT

PART	PRODUCT CODE	DESCRIPTION
	DBFORB	dedicated router bit for professional installation of Centor Architectural DH, DF, DL and DO dropbolts

INSTALLATION

Dropbolt locations in a typical configuration

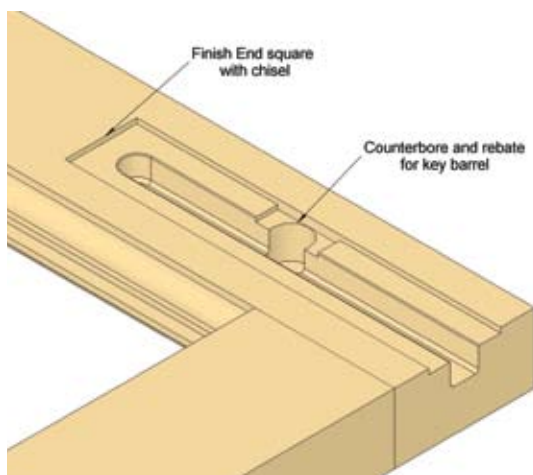

DH Installation

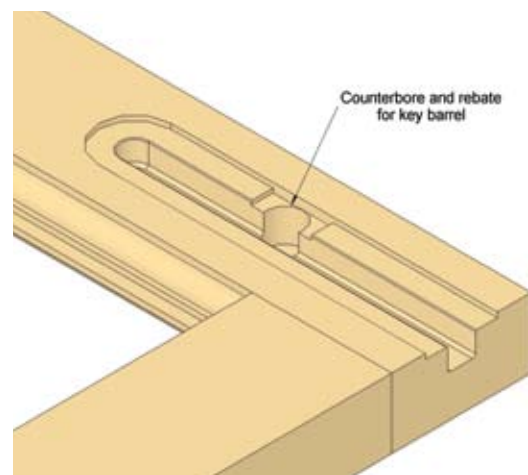

DF Installation

DOOR SIZE CALCULATION

To calculate the dimensions of the doors or openings we strongly recommend using Centor's "Doorcalc" program, which is a Microsoft® Excel spreadsheet. To manually calculate door sizing for an opening, follow the following steps:

- 1 Prepare a basic sketch of your door opening (see worked example), to visualize clearances and check sizes.
- 2 The calculation is based on all panels being equal width, using half-offset hinges (Patent Pending). Note that the allowance between each panel is 4mm although hinge thickness is less – this allowance has been determined by consultation with fabricators as the best approximation for calculation. Clearance between hinges and hinge pins, coupled with the pressure from compression seals accounts for the allowance being larger than the nominal hinge flap thickness.

3 Recommended clearances are as follows:

- Jamb to panel (door closed) 7 mm
- Panel to panel (door closed) 4 mm
- Top of panel to head 5 mm
- Bottom of panel to sill
 - 5 mm for straight guides
 - 10mm for concealed guides

4 Panel width W
 Opening width L
 Total number of panels N

Panel width is:
$$W = \frac{L - 10 - (4 \times N)}{N}$$

Worked Examples

Clear opening size 2425 high x 4200 wide (L), and a 3L x 2R arrangement.

$$W = \frac{4200 - 10 - (4 \times 5)}{5}$$

W = 834 mm

Check against your door layout:

$$L = 2(7) + 4(4) + 5(834) = 4200 \text{ OK}$$

The panel height is the opening height less the nominal top and bottom clearances:

Panel Height H = 2425 - 5 - 10 = 2410mm

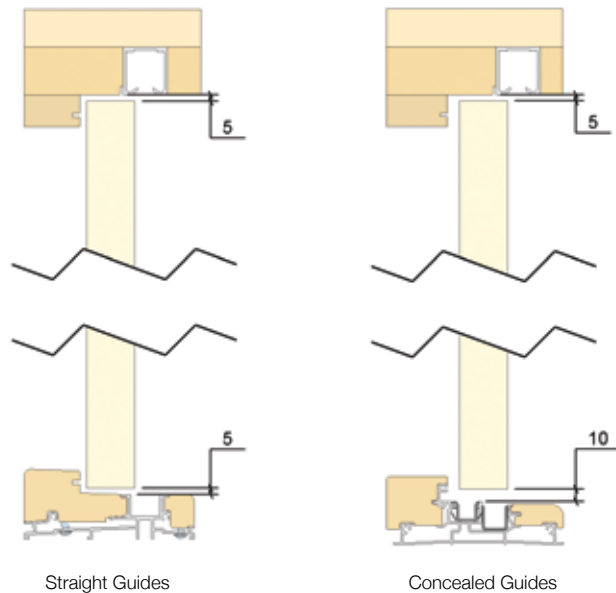

COMMON PANEL LAYOUTS

HARDWARE LEGEND

PS pivot set	HHS half offset hinge set
WPS wall pivot set	HS hinge set (flat)
ICS intermediate carrier set	EH external handle
LCS left carrier set	DB dropbolt
RCS right carrier set	

LEGEND

Passage set

Handles / Lock sets refer to Centor Door Furniture at www.centor.com.au



Dropbolts top and bottom

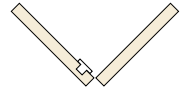

FLOATING DOOR PAIRS

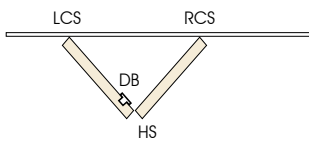

Per pair of doors

- 1 x left carrier set
- 1 x right carrier set
- 1 x hinge set
- 2 x dropbolt

Note > Wall Pivot Set recommended for doors over 2250mm in height.

HARDWARE APPLICATION (3L2R)

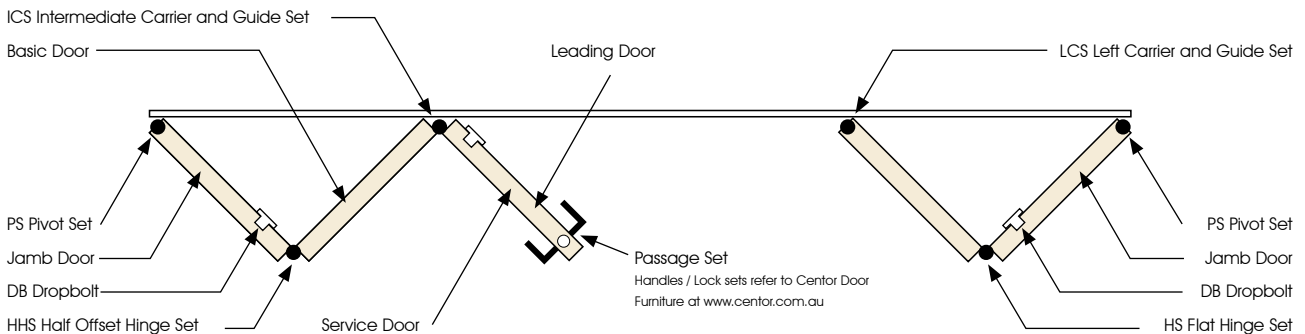

OUTWARD APPLICATION EXTERIOR HANDLE OPTION

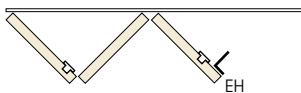

Use one exterior handle on exit door (outward system) where passage set / lock not required. Use dropbolts top and bottom to lock door from the inside only.



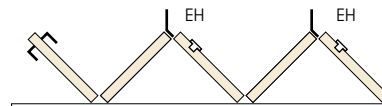

Note > Exit door not accessible from exterior in this application.

INWARD APPLICATION EXTERIOR HANDLE OPTION

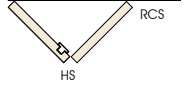
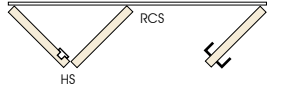
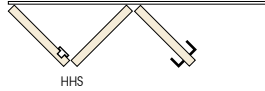
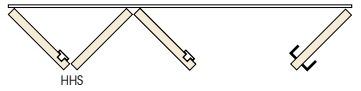
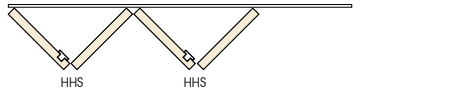
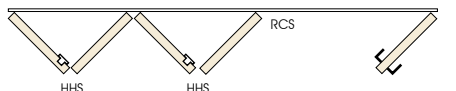
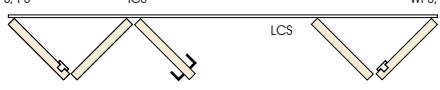
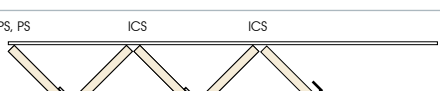
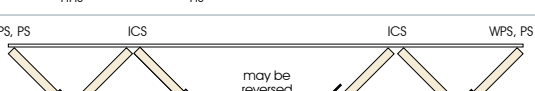

Use one exterior handle on each pair of doors (inward system) to pull open and close doors

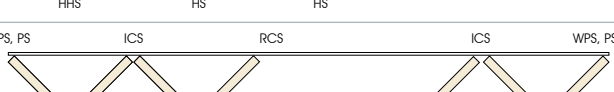
COMMON PANEL LAYOUTS

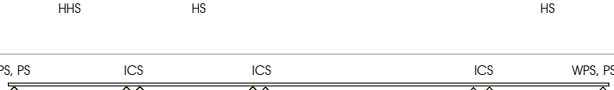
CODE	OPENING CONFIGURATION	HARDWARE
2L	<p>inside WPS, PS not accessible from exterior</p> <p>outside </p>	<p>1 x pivot set 1 x wall pivot set* 1 x right carrier set 1 x hinge set 2 x dropbolt</p>
2L1R	<p>inside WPS, PS WPS, PS</p> <p>outside </p>	<p>2 x pivot set 2 x wall pivot set* 1 x right carrier set 1 x hinge set 2 x dropbolt</p>
3L	<p>inside WPS, PS ICS</p> <p>outside </p>	<p>1 x pivot set 1 x wall pivot set* 1 x intermediate carrier set 1 x half offset hinge set 2 x dropbolt</p>
3L1R	<p>inside WPS, PS ICS WPS, PS</p> <p>outside </p>	<p>2 x pivot set 2 x wall pivot set* 1 x intermediate carrier set 1 x half offset hinge set 4 x dropbolt</p>
4L	<p>inside WPS, PS ICS RCS not accessible from exterior</p> <p>outside </p>	<p>1 x pivot set 1 x wall pivot set* 1 x intermediate carrier set 1 x right carrier set 2 x half offset hinge set 4 x dropbolt</p>
4L1R	<p>inside WPS, PS ICS WPS, PS</p> <p>outside </p>	<p>2 x pivot set 2 x wall pivot set* 1 x intermediate carrier set 1 x right carrier set 2 x half offset hinge set 4 x dropbolt</p>
3L2R	<p>inside WPS, PS ICS WPS, PS</p> <p>outside </p>	<p>2 x pivot set 2 x wall pivot set* 1 x intermediate carrier set 1 x left carrier set 1 x hinge set 1 x half offset hinge set 4 x dropbolt</p>
5L	<p>inside WPS, PS ICS ICS</p> <p>outside </p>	<p>1 x pivot set 1 x wall pivot set* 2 x intermediate carrier set 1 x hinge set 1 x half offset hinge set 4 x dropbolt</p>
3L3R	<p>inside WPS, PS ICS ICS WPS, PS</p> <p>outside </p>	<p>2 x pivot set 2 x wall pivot set* 2 x intermediate carrier set 2 x half offset hinge set 6 x dropbolt</p>
7L	<p>inside WPS, PS ICS ICS ICS</p> <p>outside </p>	<p>1 x pivot set 1 x wall pivot set* 3 x intermediate carrier set 2 x hinge set 1 x half offset hinge set 6 x dropbolt</p>
4L3R	<p>inside WPS, PS ICS RCS ICS WPS, PS</p> <p>outside </p>	<p>2 x pivot set 2 x wall pivot set* 2 x intermediate carrier set 1 x right carrier set 3 x half offset hinge set 6 x dropbolt</p>
5L2R	<p>inside WPS, PS ICS ICS RCS WPS, PS</p> <p>outside </p>	<p>2 x pivot set 2 x wall pivot set* 2 x intermediate carrier set 1 x left carrier set 2 x hinge set 1 x half offset hinge set 6 x dropbolt</p>
5L3R	<p>inside WPS, PS ICS ICS ICS WPS, PS</p> <p>outside </p>	<p>2 x pivot set 2 x wall pivot set* 3 x intermediate carrier set 1 x hinge set 2 x half offset hinge set 8 x dropbolt</p>

* Wall Pivot Sets required for doors over 2250mm

COMMON PANEL LAYOUTS

CODE	OPENING CONFIGURATION	HARDWARE
2R	<p>inside PS, WPS not accessible from exterior</p> <p>outside LCS HS</p>	1 x pivot set 1 x wall pivot set* 1 x left carrier set 1 x hinge set 2 x dropbolt
1L2R	<p>inside WPS, PS WPS, PS</p> <p>outside LCS HS</p>	2 x pivot set 2 x wall pivot set* 1 x left carrier set 1 x hinge set 2 x dropbolt
3R	<p>inside ICS WPS, PS</p> <p>outside HHS</p>	1 x pivot set 1 x wall pivot set* 1 x intermediate carrier set 1 x half offset hinge set 2 x dropbolt
1L3R	<p>inside WPS, PS ICS WPS, PS</p> <p>outside HHS</p>	2 x pivot set 2 x wall pivot set* 1 x intermediate carrier set 1 x half offset hinge set 4 x dropbolt
2L2R	<p>inside WPS, PS RCS LCS WPS, PS not accessible from exterior</p> <p>outside HS HS</p>	2 x pivot set 2 x wall pivot set* 1 x right carrier set 1 x left carrier set 2 x hinge set 4 x dropbolt
1L4R	<p>inside WPS, PS LCS ICS WPS, PS</p> <p>outside HHS HHS</p>	2 x pivot set 2 x wall pivot set* 1 x intermediate carrier set 1 x left carrier set 2 x half offset hinge set 4 x dropbolt
4R	<p>inside LCS ICS WPS, PS</p> <p>outside HHS HHS</p>	1 x pivot set 1 x wall pivot set* 1 x intermediate carrier set 1 x left carrier set 2 x half offset hinge set 4 x dropbolt
2L3R	<p>inside WPS, PS RCS ICS WPS, PS</p> <p>outside HS HHS</p>	2 x pivot set 2 x wall pivot set* 1 x intermediate carrier set 1 x right carrier set 1 x hinge set 1 x half offset hinge set 4 x dropbolt
5R	<p>inside ICS ICS WPS, PS</p> <p>outside HS HHS</p>	1 x pivot set 1 x wall pivot set* 2 x intermediate carrier set 1 x hinge set 1 x half offset hinge set 4 x dropbolt
3L4R	<p>inside WPS, PS ICS LCS ICS WPS, PS</p> <p>outside HHS HHS HHS</p>	2 x pivot set 2 x wall pivot set* 2 x intermediate carrier set 1 x left carrier set 3 x half offset hinge set 6 x dropbolt
7R	<p>inside ICS ICS ICS WPS, PS</p> <p>outside HS HS HHS</p>	1 x pivot set 1 x wall pivot set* 3 x intermediate carrier set 2 x hinge set 1 x half offset hinge set 6 x dropbolt
2L5R	<p>inside WPS, PS RCS ICS ICS WPS, PS</p> <p>outside HS HS HHS</p>	2 x pivot set 2 x wall pivot set* 2 x intermediate carrier set 1 x right carrier set 2 x hinge set 1 x half offset hinge set 6 x dropbolt
8R	<p>inside LCS ICS ICS ICS WPS, PS not accessible from exterior</p> <p>outside HHS HS HS HHS</p>	1 x pivot set 1 x wall pivot set* 3 x intermediate carrier set 1 x left carrier set 2 x hinge set 2 x half offset hinge set 8 x dropbolt

* Wall Pivot Sets required for doors over 2250mm

SURELOCK ADJUSTMENT™

Surelock™ is Centor's patented carrier pin locking system which ensures that once door heights are set at the top pivots, intermediate and end carriers, they stay set!

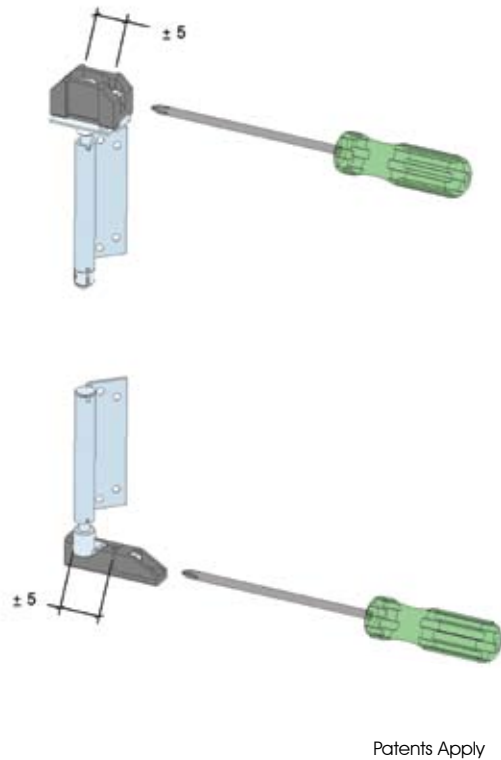
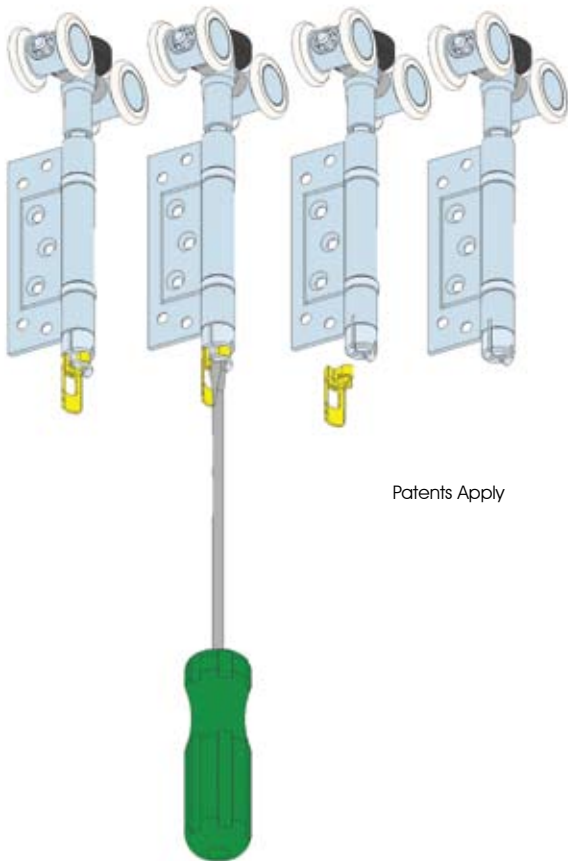

Using Surelock™ is simple

- 1 Components come supplied with a plastic shipping clip installed.
- 2 Insert a flat-bladed screwdriver into the slot and rotate the pin.
- 3 When correct adjustment is reached remove the shipping clip.
- 4 Surelock™ will snap into place when the blade and slot are aligned.
- 5 To readjust pull the blade down to disengage it from the slot, replace the shipping clip and rotate the pin.

Remove shipping clip after final installation adjustment.

While every effort has been made to ensure the accuracy of the information in this publication, Centor Architectural assume no responsibility for errors or omissions or any consequences of reliance solely on this publication.



Centor Australia Pty Ltd

ABN 96 009 716 189
telephone 1300 CENTOR
1300 236 867
facsimile 1300 CENFAX
1300 236 329
mail@centor.com.au
www.centor.com.au

BRISBANE

**Centor Australia Pty Ltd
Head Office & Factory**
997 Kingsford Smith Drive
PO Box 1550
Eagle Farm QLD 4009
telephone +61 7 3868 5777
facsimile +61 7 3868 1201

SYDNEY

Centor Australia Pty Ltd
12/9 Killo Crescent
Glendenning NSW 2761
telephone +61 2 9208 3200
facsimile +61 2 9625 2399

MELBOURNE

Centor Australia Pty Ltd
28 Keysborough Close
Keysborough VIC 3173
telephone +61 3 9709 0300
facsimile +61 3 9798 1645

ADELAIDE

Centor Australia Pty Ltd
Unit 4, 2 Endeavour Drive
PO Box 285
Port Adelaide SA 5015
telephone +61 8 8304 2577
facsimile +61 8 8304 2599

PERTH

Notchka Pty Ltd
45 Colray Avenue
Osborne Park WA 6017
telephone +61 8 9443 3266
facsimile +61 8 9443 3250
sales@notchka.com

TASMANIA

Launceston
Access Hardware Pty Ltd
42 Invermay Road
Mowbray Heights TAS 7248
telephone +61 3 6331 2533
facsimile +61 3 6331 2733
accesshw@bigpond.net.au

Hobart

Access Hardware Pty Ltd
21 Brisbane Street
Hobart TAS 7000
telephone +61 3 6231 9926
facsimile +61 3 6231 9927



202-100-030-001